

XLA XLB SHAFT MOTORS

Before finalising your installation please ask for a copy of the latest issue drawing.

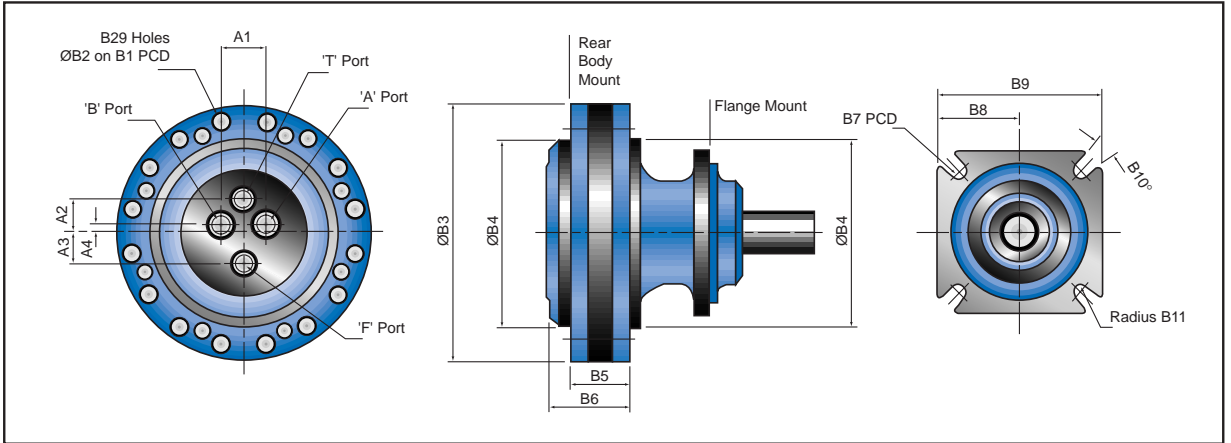

XLA __ A __ 000 __

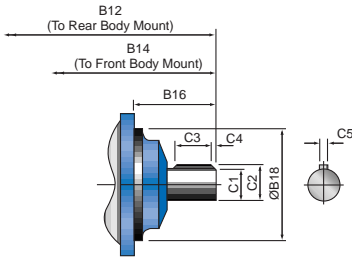

XLB __ B __ 000 __

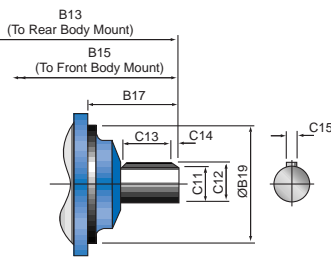

XLB __ F __ 000 __

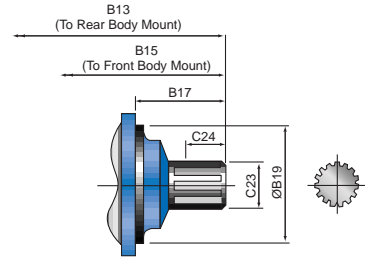

XLA __ D __ 000 __

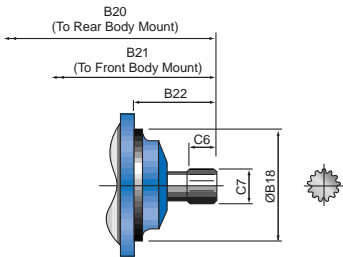

XLB __ C __ 000 __

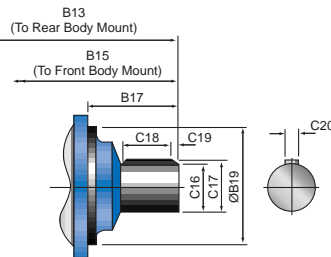

XLA __ H __ 00 __

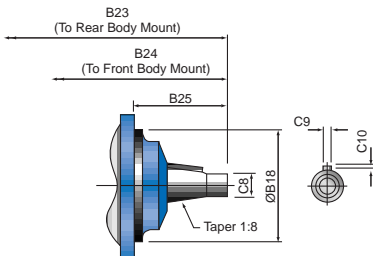

XLB __ E __ 000 __

